

# ULTRA MINIATURE RELAY SLIM SIGNAL RELAY

## FTR-B4 Series

**RoHS compliant**

■ **FEATURES**

- Ultra miniature slim type relay for surface mounting
  - Height: 9.3 mm maximum (THT)  
10 mm maximum (SMT)
  - Weight: Approximately 1.0 g
- UL/CSA recognized
- Conforms to Bellcore & FCC part 68, and Telcordia & FCC part 68
- Conforms to UL1950 / CSA 950, IEC 950 / EN60950 spacing and high breakdown voltage
  - Clearance: 1.0mm
  - Creepage: 1.6mm
  - Basic insulation, 150V working voltage, pollution degree 2
- **HIGH RELIABILITY**
  - Bifurcated contacts
- Low power consumption 140 mV (standard), 100 mW (latching)
- RoHS compliant since date code: 0430B8  
Please see page 8 for more information

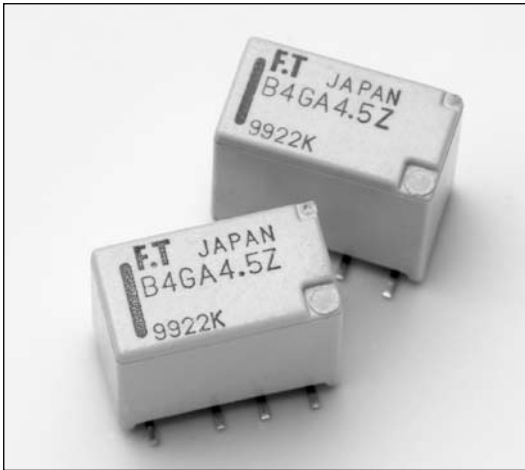

■ **ORDERING INFORMATION**

FTR-B4   C   A   4.5   Z   -B   05  
 [Example]   (a)   (b)(c)   (d)   (e)   (f)   (g)

(a)	Series Name	FTR-B4 Series
(b)	Terminal type	C: Through hole type G: surface mount type S: surface mount type - reduced mounting area
(c)	Operation function	A: standard type B: latching type
(d)	Coil Number	Nominal voltage
(e)	Contact material	Z: gold plated silver alloy
(f)	Relay enclosing direction*	B: standard enclosing direction
(g)	Number of relays per reel*	05: 500 (standard)

Remarks: Actual marking on relay would not carry code FTR and be as below:

Ordering code                                      Actual marking

Notes: \*FTR-B4CA4.5Z                      →                      B4CA4.5Z

- Only surface mount types (G and S) are applicable

- All relays are packaged in tubes unless P/N ends with -B05

# FTR-B4 Series

## ■ COIL DATA CHART

Standard type

MODEL	Rated coil voltage	Coil resistance (±10%)	Operating voltage	Release voltage*	Rated power consumption
FTR-B4( )A1.5Z	1.5VDC	16.1 Ω	+1.13V	+0.15V	140mW
FTR-B4( )A003Z	3VDC	64.3 Ω	+2.25V	+0.3V	140mW
FTR-B4( )A4.5Z	4.5VDC	145 Ω	+3.38V	+0.45V	140mW
FTR-B4( )A006Z	6VDC	257 Ω	+4.5V	+0.6V	140mW
FTR-B4( )A009Z	9VDC	579 Ω	+6.75V	+0.9V	140mW
FTR-B4( )A012Z	12VDC	1,028 Ω	+9.0V	+1.2V	140mW
FTR-B4( )A024Z	24VDC	2,504 Ω	+18.0V	+2.4V	230mW

\* Pulse driven

Note: All values in the table are measured at 20°C.

Latching type (1 coil)

MODEL	Rated coil voltage	Coil resistance (±10%)	Set voltage	Release voltage	Rated power consumption
FTR-B4 ( )B1.5Z	1.5VDC	22.5 Ω	+1.13V	-1.13V	100mW
FTR-B4 ( )B003Z	3VDC	90 Ω	+2.25V	-2.25V	100mW
FTR-B4 ( )B4.5Z	4.5VDC	203 Ω	+3.38V	-3.38V	100mW
FTR-B4 ( )B006Z	6VDC	360 Ω	+4.5V	-4.5V	100mW
FTR-B4 ( )B009Z	9VDC	810 Ω	+6.75V	-6.75V	100mW
FTR-B4 ( )B012Z	12VDC	1,440 Ω	+9.0V	-9.0V	100mW
FTR-B4 ( )B024Z	24VDC	4,800 Ω	+18.0V	-18.0V	120mW

\* Pulse driven

Note: All values in the table are measured at 20°C.

# FTR-B4 Series

## ■ SPECIFICATIONS

		Standard Type	Latching Type
		FTR-B4-CA ( ) Z FTR-B4-GA ( ) Z FTR-B4-SA ( ) Z	FTR-B4-CB ( ) Z FTR-B4-GB ( ) Z FTR-B4-SB ( ) Z
Contact	Arrangement	2Form C	
	Contact material	Gold overlay silver alloy	
	Contact type	Bifurcated contact (cross-bar)	
	Contact resistance (initial value)	100mΩ maximum at 6VDC 1	
	Contact rating	30 VDC 1A, 125 VAC 0.3 A (resistive)	
	Maximum carrying current	1A	
	Maximum switching power	62.5 VA / 30W	
	Maximum switching voltage	250 VAC. 220 VDC	
	Maximum switching current	1A	
	Maximum switching load*	10m VDC, 0.01mA*	
	Capacitance	Approximately 0.7 pF (between open contacts) Approximately 0.7 pF (adjacent contacts) Approximately 1.0 pF (between coil and contacts)	
Coil	Nominal power (at 20°C)	140 mW up to 230 mW	100 mW up to 130 mW
	Operate power (at 20°C)	80 mW up to 130 mW	57 mW up to 68 mW
	Operating temperature (no frost)	-40°C to +85°C	
Time value	Operate (at nominal voltage, without bounce)	3ms maximum	3ms maximum (set)
	Release (at nominal voltage, without bounce)	3ms maximum	3ms maximum (reset)
Insulation	Resistance	Minimum 1,000MΩ	
	Dielectric strength	between open contacts	1,000 VAC 1 minute
		between adjacent contacts	1,000 VAC 1 minute
		between coil and contacts	1,500 VAC 1 minute
	Surge strength	between open contacts	1,500 V (at 10 x 160μs) [FCC Part 68]
		between adjacent contacts	1,500 V (at 10 x 160μs) [FCC Part 68]
between coil and contacts		1,500 V (at 10 x 160μs) [FCC Part 68] 2,500 V (at 2 x 10μs) [Bellcore]	
Life	Mechanical	50 x 10 <sup>6</sup> operations (at 3 Hz)	
	Electrical (resistive load)	100 x 10 <sup>3</sup> ops. min. at 1A, 30 VDC (at 0.5 Hz) 100 x 10 <sup>3</sup> ops. min. at 0.3A, 30 VDC (at 0.5 Hz)	
Vibration resistance	Misoperation	10 to 55 Hz at double amplitude of 3 mm	
	Endurance	10 to 55 Hz at double amplitude of 5 mm	
Shock resistance	Misoperation	Min. 750 m/s <sup>2</sup>	
	Endurance	Min. 1,000 m/s <sup>2</sup>	
Weight	Approximately 1.0 g		

\*1 Minimum switching loads mentioned above are reference values. Please perform the confirmation test with the actual load before production since reference values may vary according to switching frequencies, environmental conditions and expected reliability levels.

## CHARACTERISTIC DATA

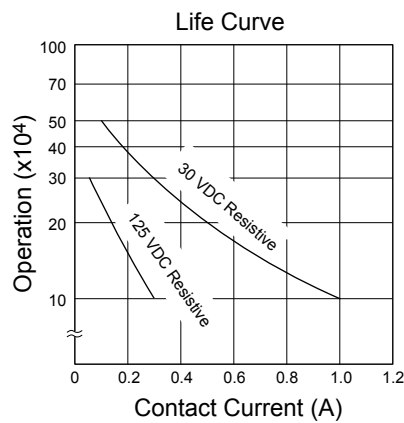
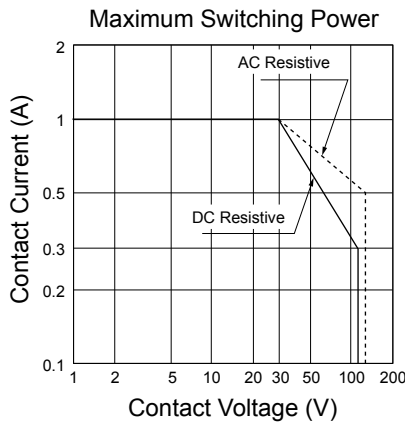
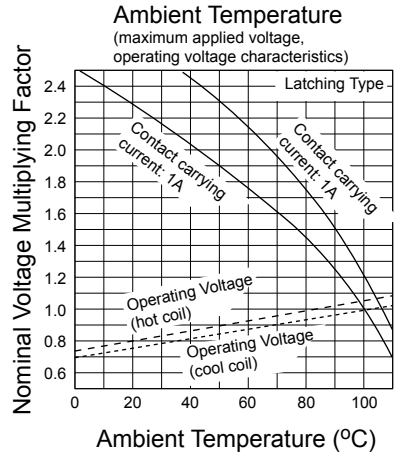
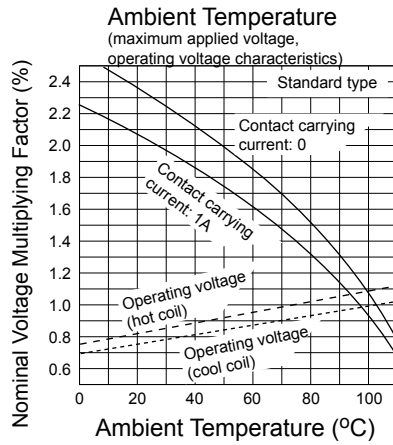
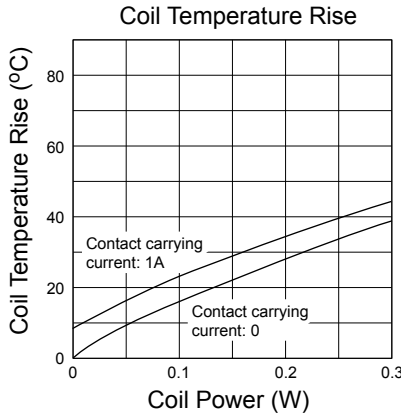
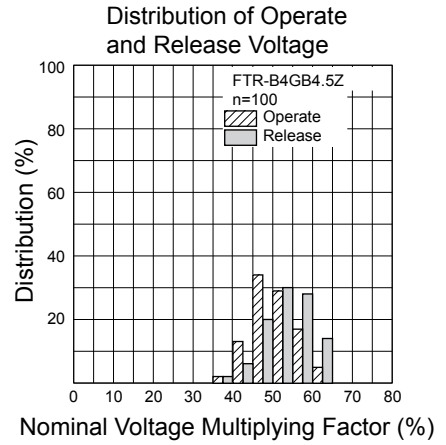
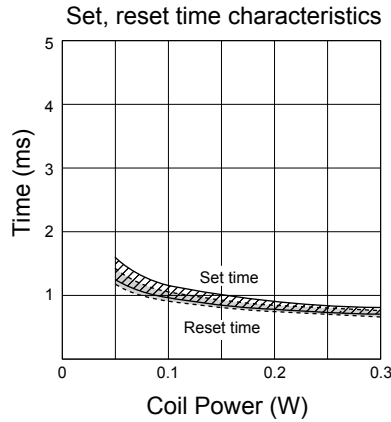
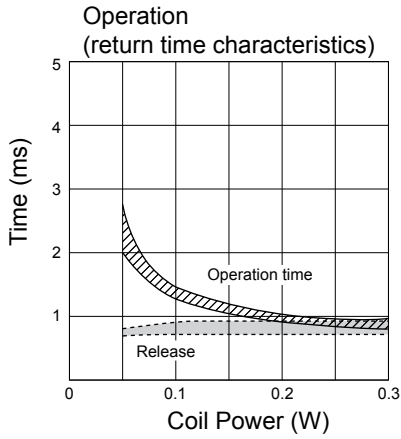

# FTR-B4 Series

## REFERENCE DATA

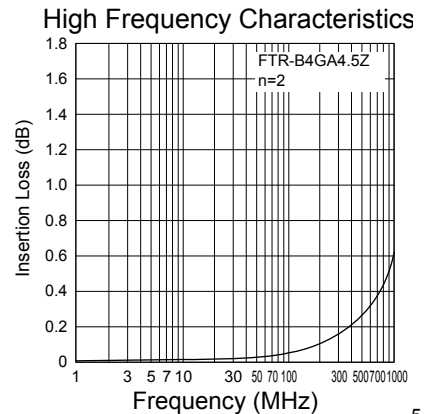
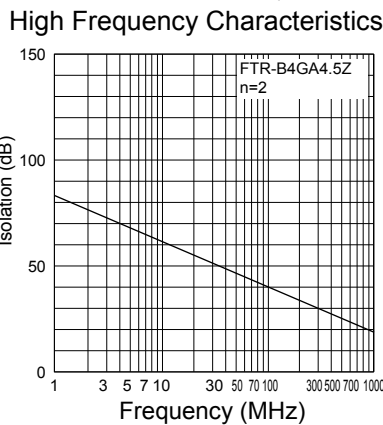
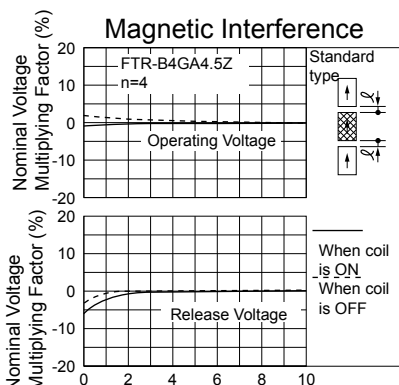
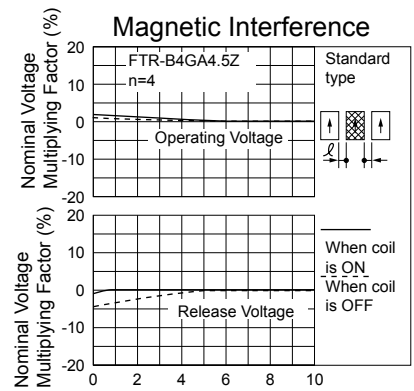
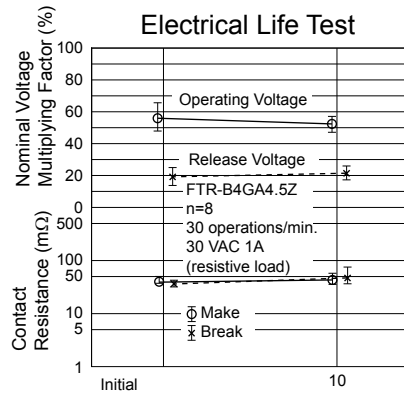
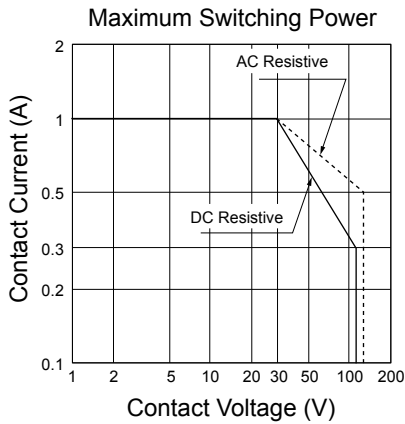
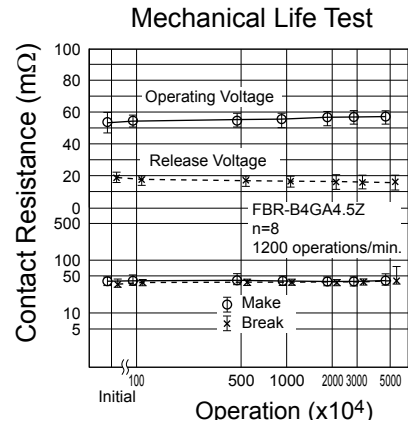
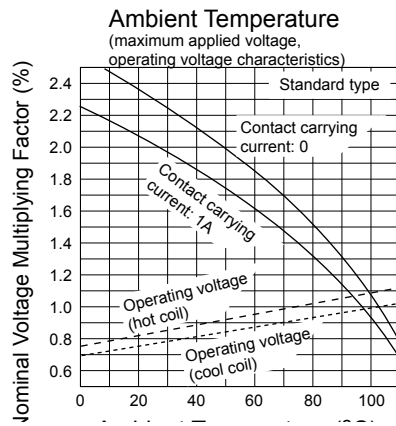
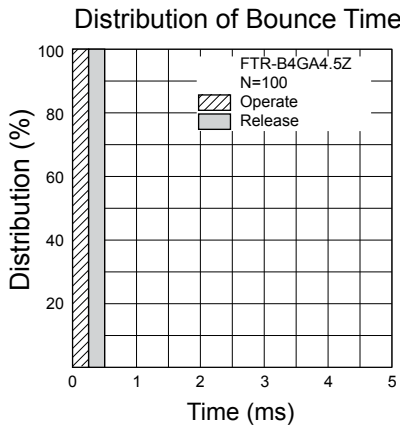
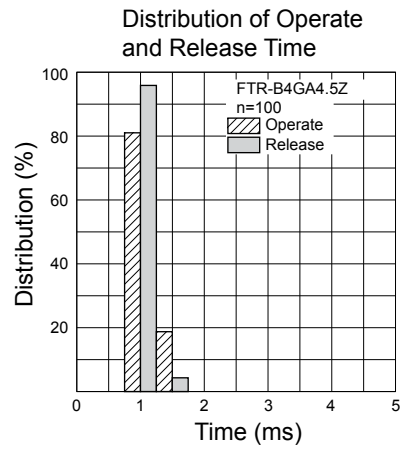
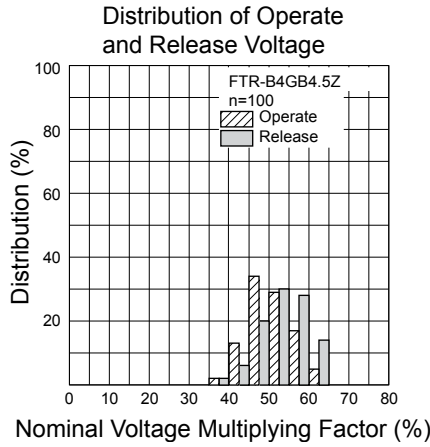
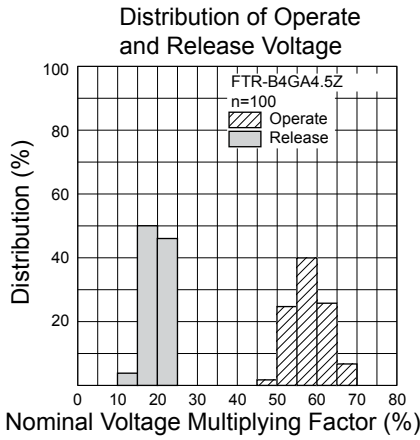

# FTR-B4 Series

## ■ DIMENSIONS AND SCHEMATICS

Through hole type

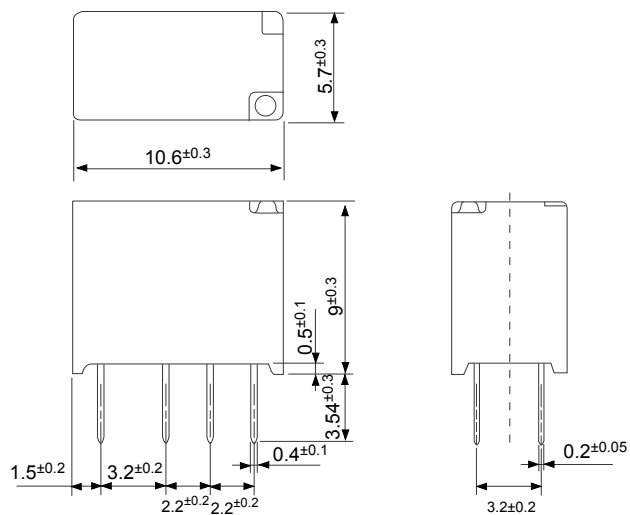

Recommended mounting pad  
(Tolerance:  $\pm 0.1\text{mm}$ )

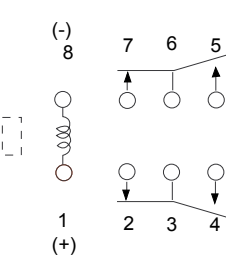

Terminal designations  
(Top view de-energized position)

Surface mount type (standard)

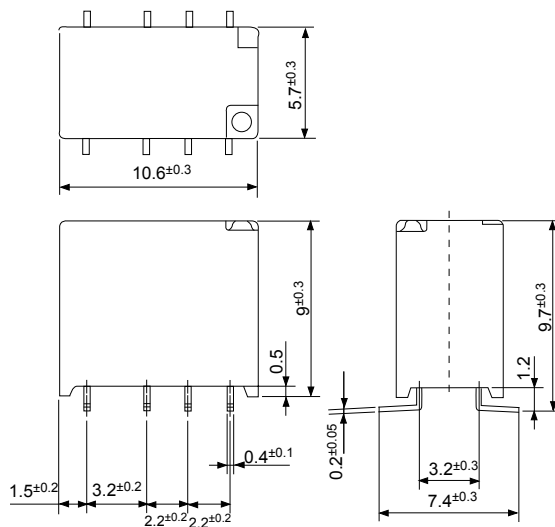

Recommended mounting pad  
(Tolerance:  $\pm 0.1\text{mm}$ )

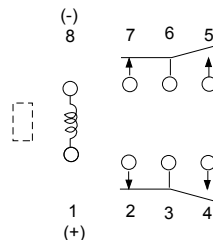

Terminal designations  
(Top view de-energized position)

## ■ DIMENSIONS AND SCHEMATICS

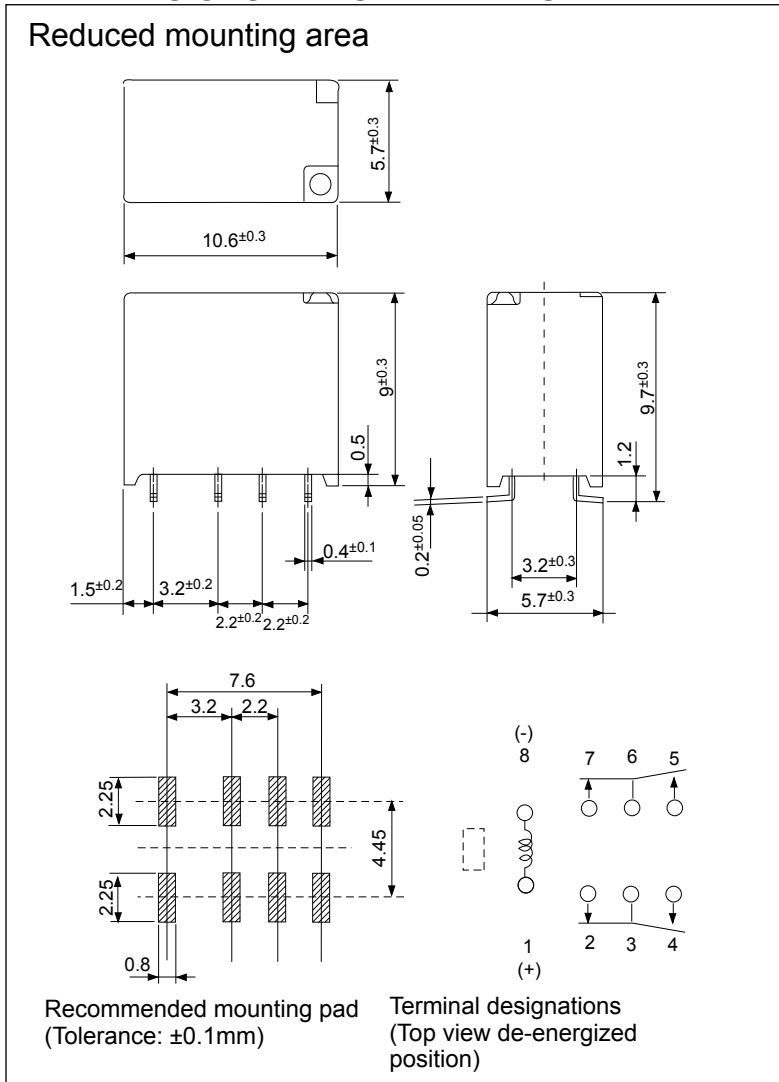

## ■ RECOMMENDED SOLDERING CONDITIONS (TEMPERATURE PROFILE)

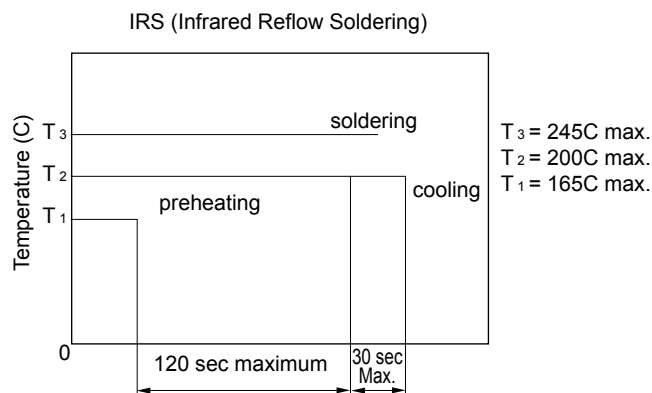

- Note:
1. Temperature profiles show the temperature of PC board surface.
  2. Please perform soldering test with your actual PC board before mass production, since the temperatures of PC board surfaces vary according to the size of PC board, status of parts mounting and heating method.

## ■ PRECAUTIONS

- For details on general precautions, refer to the section on technical descriptions.
- Since this is a polar relay, follow the instructions of the internal wiring diagram for the +- connections of the coil.
- Note that the terminal array and internal wiring of the surface mount relay are a top view.

## RoHS Compliance and Lead Free Relay Information

### 1. General Information

- Relays produced after the specific date code that is indicated on each data sheet are lead-free now. Most of our signal and power relays are lead-free. Please refer to Lead-Free Status Info. (<http://www.fujitsu.com/us/downloads/MICRO/fcai/relays/lead-free-letter.pdf>)
- Lead free solder paste currently used in relays is Sn-3.0Ag-0.5Cu. From February 2005 forward Sn-3.0CU-Ni will be used for the FTR-B3 and FTR-B4 series relays.
- All signal and most power relays also comply with RoHS. Please refer to individual data sheets. Relays that are RoHS compliant do not contain the 5 hazardous materials that are restricted by RoHS directive (lead, mercury, chromium IV, PBB, PBDE).
- It has been verified that using lead-free relays in lead assembly process will not cause any problems (compatible).
- "LF" is marked on each outer and inner carton. (No marking on individual relays).
- To avoid leaded relays (for lead-free sample, etc.) please consult with area sales office.
  - We will ship leaded relays as long as the leaded relay inventory exists.

Note: Cadmium was exempted from RoHS on October 21, 2005. (Amendment to Directive 2002/95/EC)

### 2. Recommended Lead Free Solder Profile

- Recommended solder paste Sn-3.0Ag-0.5Cu and Sm-3.0 Cu-Ni (only FTR-B3 and FTR-B4 from February 2005).

#### Reflow Solder condition

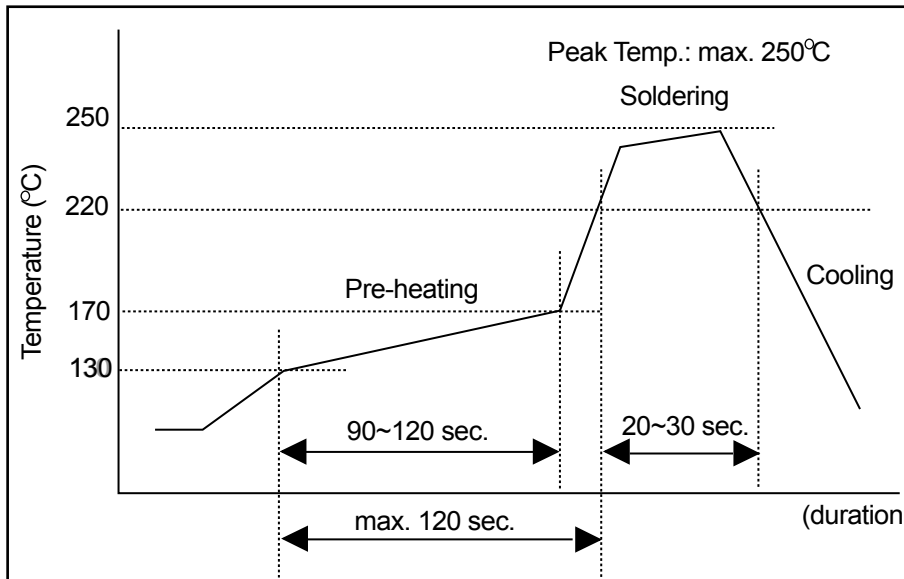

#### Flow Solder condition:

Pre-heating: maximum 120°C  
Soldering: dip within 5 sec. at 260°C solder bath

#### Solder by Soldering Iron:

Soldering Iron  
Temperature: maximum 360°C  
Duration: maximum 3 sec.

We highly recommend that you confirm your actual solder conditions

### 3. Moisture Sensitivity

- Moisture Sensitivity Level standard is not applicable to electromechanical relays.

### 4. Tin Whisker

- SnAgCu and SnCuNi solder is known as low risk of tin whisker. No considerable length whisker was found by our in-house test.



## Fujitsu Components International Headquarter Offices

### Japan

Fujitsu Component Limited  
Gotanda-Chuo Building  
3-5, Higashigotanda 2-chome, Shinagawa-ku  
Tokyo 141, Japan  
Tel: (81-3) 5449-7010  
Fax: (81-3) 5449-2626  
Email: [promothq@ft.ed.fujitsu.com](mailto:promothq@ft.ed.fujitsu.com)  
Web: [www.fcl.fujitsu.com](http://www.fcl.fujitsu.com)

### North and South America

Fujitsu Components America, Inc.  
250 E. Caribbean Drive  
Sunnyvale, CA 94089 U.S.A.  
Tel: (1-408) 745-4900  
Fax: (1-408) 745-4970  
Email: [components@us.fujitsu.com](mailto:components@us.fujitsu.com)  
Web: <http://us.fujitsu.com/relays/>

### Europe

Fujitsu Components Europe B.V.  
Diamantlaan 25  
2132 WV Hoofddorp  
Netherlands  
Tel: (31-23) 5560910  
Fax: (31-23) 5560950  
Email: [info@fceu.fujitsu.com](mailto:info@fceu.fujitsu.com)  
Web: [emea.fujitsu.com/components/](http://emea.fujitsu.com/components/)

### Asia Pacific

Fujitsu Components Asia Ltd.  
102E Pasir Panjang Road  
#01-01 Citilink Warehouse Complex  
Singapore 118529  
Tel: (65) 6375-8560  
Fax: (65) 6273-3021  
Email: [fcac@fcac.fujitsu.com](mailto:fcac@fcac.fujitsu.com)  
Web: <http://www.fujitsu.com/sg/services/micro/components/>

©2007 Fujitsu Components America, Inc. All rights reserved. All trademarks or registered trademarks are the property of their respective owners.

Fujitsu Components America or its affiliates do not warrant that the content of datasheet is error free. In a continuing effort to improve our products Fujitsu Components America, Inc. or its affiliates reserve the right to change specifications/datasheets without prior notice.  
Rev. February 19, 2007